

FMG2G400US60

Molding Type Module

General Description

Fairchild IGBT Power Module provides low conduction and switching losses as well as short circuit ruggedness. It's designed for the applications such as motor control, uninterrupted power supplies (UPS) and general inverters where short-circuit ruggedness is required.

Features

- Short Circuit Rated Time; 10us @ $T_C = 100^\circ\text{C}$, $V_{GE} = 15\text{V}$
- High Speed Switching
- Low Saturation Voltage : $V_{CE(sat)} = 2.1\text{V}$ @ $I_C = 400\text{A}$
- High Input Impedance
- Fast & Soft Anti-Parallel FWD
- UL Certified No.E209204

Application

- AC & DC Motor Controls
- General Purpose Inverters
- Robotics
- Servo Controls
- UPS

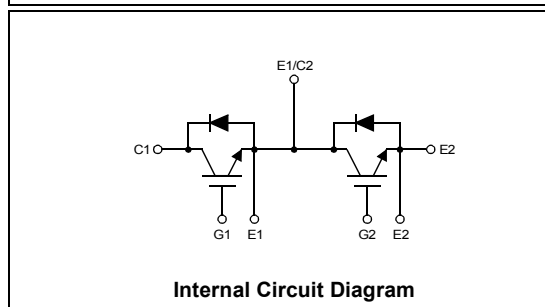
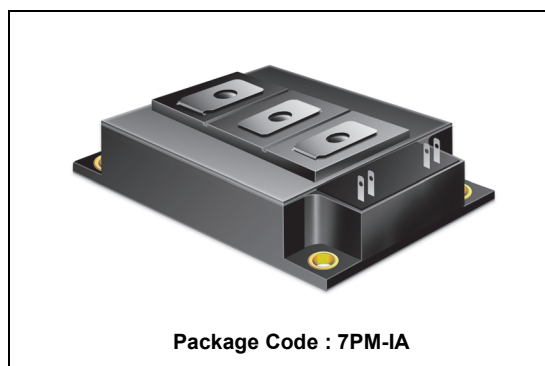

Absolute Maximum Ratings $T_C = 25^\circ\text{C}$ unless otherwise noted

| Symbol | Description | FMG2G400US60 | Units |
|-----------------|-------------------------------------------------------------|--------------|------------------|
| V_{CES} | Collector-Emitter Voltage | 600 | V |
| V_{GES} | Gate-Emitter Voltage | ± 20 | V |
| I_C | Collector Current @ $T_C = 80^\circ\text{C}$ | 400 | A |
| $I_{CM(1)}$ | Pulsed Collector Current | 800 | A |
| I_F | Diode Continuous Forward Current @ $T_C = 80^\circ\text{C}$ | 400 | A |
| I_{FM} | Diode Maximum Forward Current | 800 | A |
| P_D | Maximum Power Dissipation @ $T_C = 25^\circ\text{C}$ | 1136 | W |
| T_{SC} | Short Circuit Withstand Time @ $T_C = 100^\circ\text{C}$ | 10 | us |
| T_J | Operating Junction Temperature | -40 to +150 | $^\circ\text{C}$ |
| T_{STG} | Storage Temperature Range | -40 to +125 | $^\circ\text{C}$ |
| V_{ISO} | Isolation Voltage @ AC 1minute | 2500 | V |
| Mounting Torque | Power Terminal Screw : M6 | 4.0 | N.m |
| | Mounting Screw : M6 | 4.0 | N.m |

Notes :

(1) Repetitive rating : Pulse width limited by max. junction temperature

Electrical Characteristics of IGBT T_C = 25°C unless otherwise noted

| Symbol | Parameter | Test Conditions | Min. | Typ. | Max. | Units |
|-------------------------------------|-----------------------------------------|-----------------------------------------------------------|------|------|-------|-------|
| Off Characteristics | | | | | | |
| BV _{CES} | Collector-Emitter Breakdown Voltage | V _{GE} = 0V, I _C = 250uA | 600 | -- | -- | V |
| ΔBV _{CES} /ΔT _J | Temperature Coeff. of Breakdown Voltage | V _{GE} = 0V, I _C = 1mA | -- | 0.6 | -- | V/°C |
| I _{CES} | Collector Cut-Off Current | V _{CE} = V _{CES} , V _{GE} = 0V | -- | -- | 250 | uA |
| I _{GES} | Gate - Emitter Leakage Current | V _{GE} = V _{GES} , V _{CE} = 0V | -- | -- | ± 100 | nA |

On Characteristics

| | | | | | | |
|----------------------|-----------------------------------------|-----------------------------------------------------------|-----|-----|-----|---|
| V _{GE(th)} | Gate - Emitter Threshold Voltage | I _C = 400mA, V _{CE} = V _{GE} | 5.0 | 6.5 | 8.5 | V |
| V _{CE(sat)} | Collector to Emitter Saturation Voltage | I _C = 400A, V _{GE} = 15V | -- | 2.1 | 2.7 | V |

Switching Characteristics

| | | | | | | |
|---------------------|------------------------------|------------------------------------------------------------------------------------------------------------------------------------------|----|------|-----|----|
| t _{d(on)} | Turn-On Delay Time | V _{CC} = 300 V, I _C = 400A, R _G = 2Ω, V _{GE} = 15V, Inductive Load, T _C = 25°C | -- | 160 | -- | ns |
| t _r | Rise Time | | -- | 220 | -- | ns |
| t _{d(off)} | Turn-Off Delay Time | | -- | 230 | -- | ns |
| t _f | Fall Time | | -- | 150 | 250 | ns |
| E _{on} | Turn-On Switching Loss | | -- | 9.5 | -- | mJ |
| E _{off} | Turn-Off Switching Loss | -- | 21 | -- | mJ | |
| t _{d(on)} | Turn-On Delay Time | V _{CC} = 300 V, I _C = 400A, R _G = 2Ω, V _{GE} = 15V, Inductive Load, T _C = 125°C | -- | 320 | -- | ns |
| t _r | Rise Time | | -- | 240 | -- | ns |
| t _{d(off)} | Turn-Off Delay Time | | -- | 290 | -- | ns |
| t _f | Fall Time | | -- | 230 | -- | ns |
| E _{on} | Turn-On Switching Loss | | -- | 11 | -- | mJ |
| E _{off} | Turn-Off Switching Loss | -- | 26 | -- | mJ | |
| T _{sc} | Short Circuit Withstand Time | V _{CC} = 300 V, V _{GE} = 15V @ T _C = 100°C | 10 | -- | -- | us |
| Q _g | Total Gate Charge | V _{CE} = 300 V, I _C = 400A, V _{GE} = 15V | -- | 1200 | -- | nC |
| Q _{ge} | Gate-Emitter Charge | | -- | 310 | -- | nC |
| Q _{gc} | Gate-Collector Charge | | -- | 490 | -- | nC |

Electrical Characteristics of DIODE T_C = 25°C unless otherwise noted

| Symbol | Parameter | Test Conditions | Min. | Typ. | Max. | Units | |
|-----------------|-------------------------------------|-----------------------|------------------------|------|------|-------|----|
| V _{FM} | Diode Forward Voltage | I _F = 400A | T _C = 25°C | -- | 1.9 | 2.8 | V |
| | | | T _C = 100°C | -- | 1.8 | -- | |
| t _{rr} | Diode Reverse Recovery Time | I _F = 400A | T _C = 25°C | -- | 90 | 130 | ns |
| | | | T _C = 100°C | -- | 130 | -- | |
| I _{rr} | Diode Peak Reverse Recovery Current | di / dt = 800 A/us | T _C = 25°C | -- | 35 | 46 | A |
| | | | T _C = 100°C | -- | 76 | -- | |
| Q _{rr} | Diode Reverse Recovery Charge | I _F = 400A | T _C = 25°C | -- | 1580 | 3000 | nC |
| | | | T _C = 100°C | -- | 4940 | -- | |

Thermal Characteristics

| Symbol | Parameter | Typ. | Max. | Units |
|------------------|-----------------------------------------------|------|------|-------|
| R _{θJC} | Junction-to-Case (IGBT Part, per 1/2 Module) | -- | 0.11 | °C/W |
| R _{θJC} | Junction-to-Case (DIODE Part, per 1/2 Module) | -- | 0.18 | °C/W |
| R _{θJC} | Case-to-Sink (Conductive grease applied) | 0.03 | -- | °C/W |
| Weight | Weight of Module | 360 | -- | g |

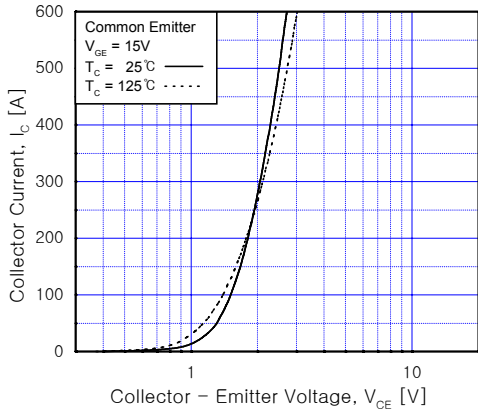

Fig 1. Typical Output Characteristics

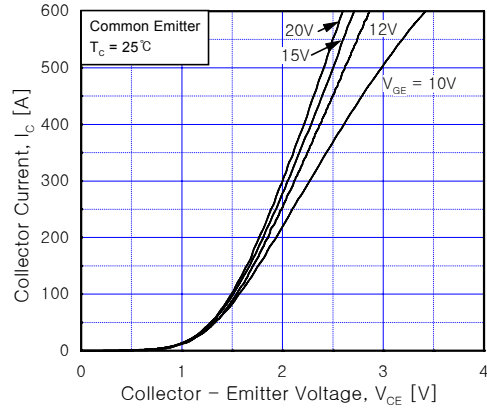

Fig 2. Typical Saturation Voltage Characteristics

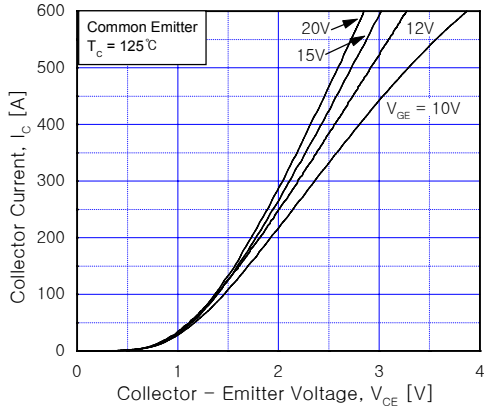

Fig 3. Typical Saturation Voltage Characteristics

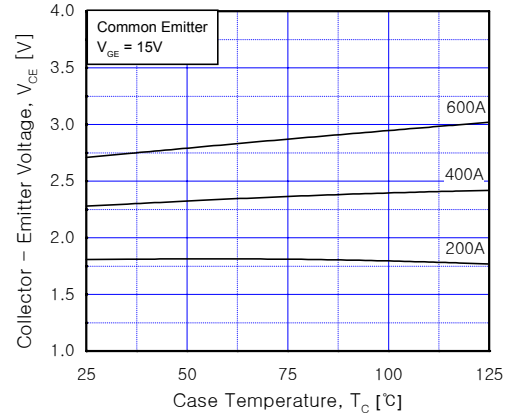

Fig 4. Saturation Voltage vs. Case Temperature at Variant Current Level

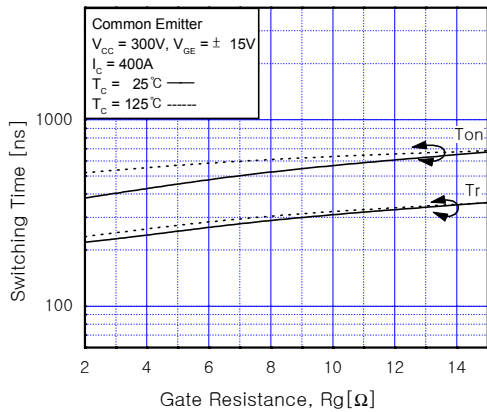

Fig 5. Turn-On Characteristics vs. Gate Resistance

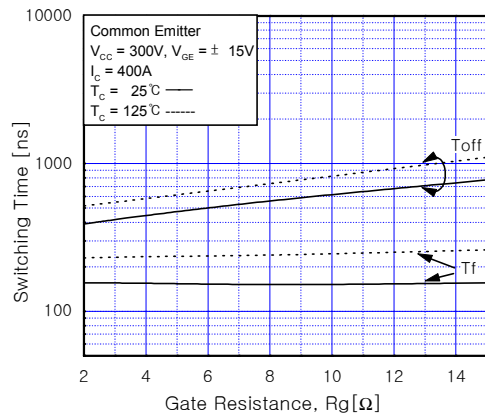

Fig 6. Turn-Off Characteristics vs. Gate Resistance

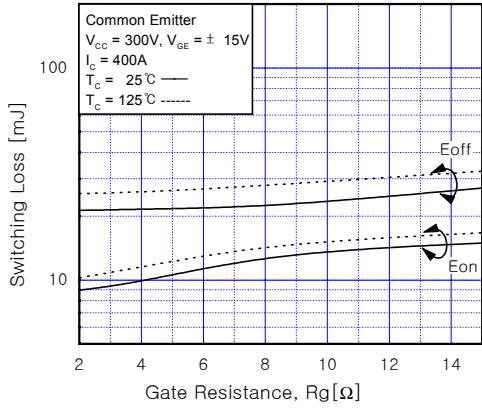

Fig 7. Switching Loss vs. Gate Resistance

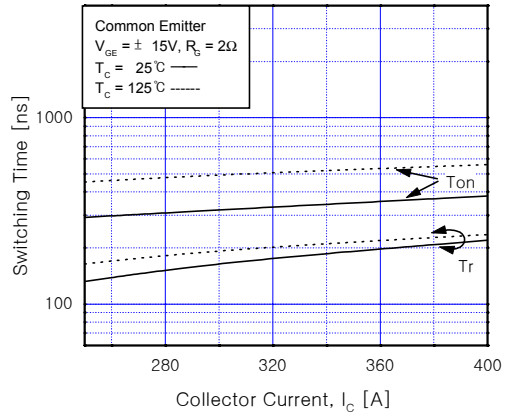

Fig 8. Turn-On Characteristics vs. Collector Current

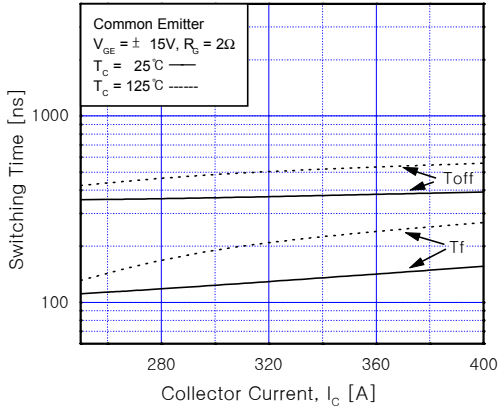

Fig 9. Turn-Off Characteristics vs. Collector Current

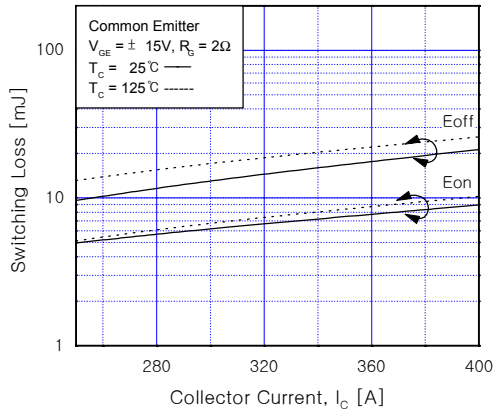

Fig 10. Switching Loss vs. Collector Current

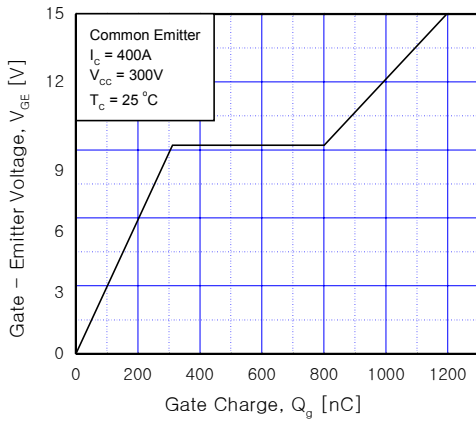

Fig 11. Gate Charge Characteristics

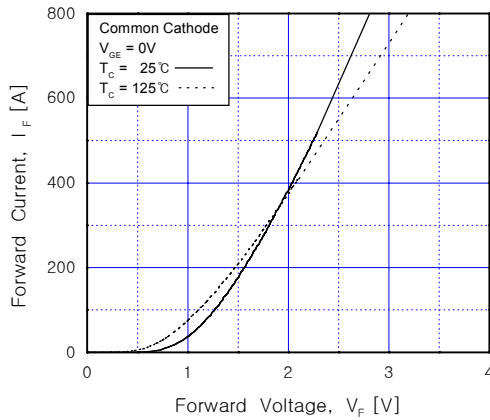

Fig 12. Forward Characteristics (diode)

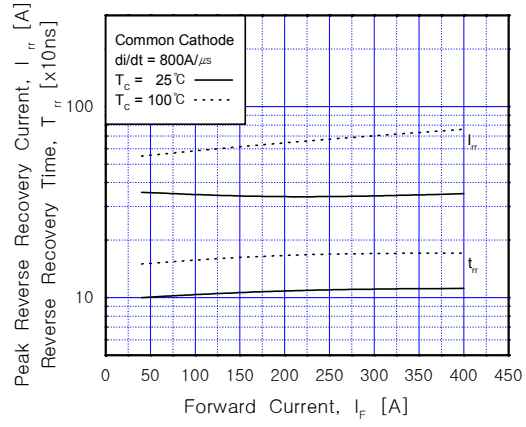
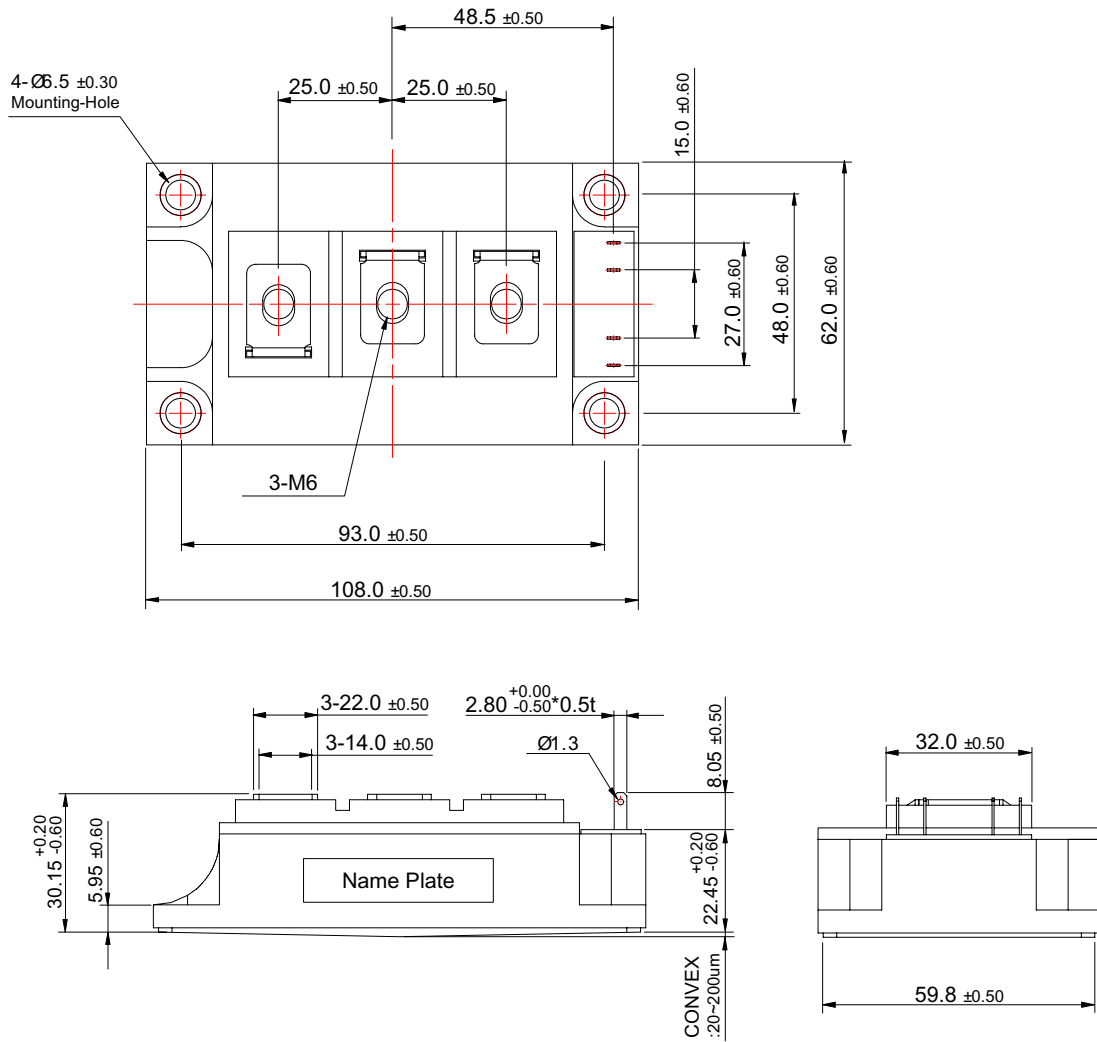

Fig 13. Reverse Recovery Characteristics(diode)

Package Dimension

7PM-IA



Dimensions in Millimeters

TRADEMARKS

The following are registered and unregistered trademarks Fairchild Semiconductor owns or is authorized to use and is not intended to be an exhaustive list of all such trademarks.

| | | | | |
|--------------------------------------------------|---------------------------------|--------------------------------|---------------------------------|-----------------------------|
| ACE ^x [™] | FACT [™] | ImpliedDisconnect [™] | PACMAN [™] | SPM [™] |
| ActiveArray [™] | FACT Quiet series [™] | ISOPLANAR [™] | POP [™] | Stealth [™] |
| Bottomless [™] | FAST [®] | LittleFET [™] | Power247 [™] | SuperSOT [™] -3 |
| CoolFET [™] | FAST ^r [™] | MicroFET [™] | PowerTrench [®] | SuperSOT [™] -6 |
| CROSSVOLT [™] | FRFET [™] | MicroPak [™] | QFET [™] | SuperSOT [™] -8 |
| DOME [™] | GlobalOptoisolator [™] | MICROWIRE [™] | QS [™] | SyncFET [™] |
| EcoSPARK [™] | GTO [™] | MSX [™] | QT Optoelectronics [™] | TinyLogic [®] |
| E ² CMOS [™] | HiSeC [™] | MSXPro [™] | Quiet Series [™] | TruTranslation [™] |
| EnSigna [™] | I ² C [™] | OCX [™] | RapidConfigure [™] | UHC [™] |
| Across the board. Around the world. [™] | | OCXPro [™] | RapidConnect [™] | UltraFET [®] |
| The Power Franchise [™] | | OPTOLOGIC [®] | SILENT SWITCHER [®] | VCX [™] |
| Programmable Active Droop [™] | | OPTOPLANAR [™] | SMART START [™] | |

DISCLAIMER

FAIRCHILD SEMICONDUCTOR RESERVES THE RIGHT TO MAKE CHANGES WITHOUT FURTHER NOTICE TO ANY PRODUCTS HEREIN TO IMPROVE RELIABILITY, FUNCTION OR DESIGN. FAIRCHILD DOES NOT ASSUME ANY LIABILITY ARISING OUT OF THE APPLICATION OR USE OF ANY PRODUCT OR CIRCUIT DESCRIBED HEREIN; NEITHER DOES IT CONVEY ANY LICENSE UNDER ITS PATENT RIGHTS, NOR THE RIGHTS OF OTHERS.

LIFE SUPPORT POLICY

FAIRCHILD'S PRODUCTS ARE NOT AUTHORIZED FOR USE AS CRITICAL COMPONENTS IN LIFE SUPPORT DEVICES OR SYSTEMS WITHOUT THE EXPRESS WRITTEN APPROVAL OF FAIRCHILD SEMICONDUCTOR INTERNATIONAL.

As used herein:

1. Life support devices or systems are devices or systems which, (a) are intended for surgical implant into the body, or (b) support or sustain life, or (c) whose failure to perform when properly used in accordance with instructions for use provided in the labeling, can be reasonably expected to result in significant injury to the user.
2. A critical component is any component of a life support device or system whose failure to perform can be reasonably expected to cause the failure of the life support device or system, or to affect its safety or effectiveness.

PRODUCT STATUS DEFINITIONS

Definition of Terms

| Datasheet Identification | Product Status | Definition |
|--------------------------|------------------------|-----------------------------------------------------------------------------------------------------------------------------------------------------------------------------------------------------------------------|
| Advance Information | Formative or In Design | This datasheet contains the design specifications for product development. Specifications may change in any manner without notice. |
| Preliminary | First Production | This datasheet contains preliminary data, and supplementary data will be published at a later date. Fairchild Semiconductor reserves the right to make changes at any time without notice in order to improve design. |
| No Identification Needed | Full Production | This datasheet contains final specifications. Fairchild Semiconductor reserves the right to make changes at any time without notice in order to improve design. |
| Obsolete | Not In Production | This datasheet contains specifications on a product that has been discontinued by Fairchild semiconductor. The datasheet is printed for reference information only. |